



■ Features

- Universal AC input / Full range
- Built-in active PFC function
- Protections: Short circuit / Overload / Over voltage / Over temperature
- Cooling by free air convection
- Can be installed on DIN rail TS-35/7.5 or 15
- UL 508 (industrial control equipment) approved
- EN61000-6-2(EN50082-2) industrial immunity level
- 100% full load burn-in test
- 3 years warranty

■ Applications

- Industrial control system
- Factory automation
- Electro-mechanical apparatus

■ Description

NDR-480 is one economical slim 480W Din rail power supply series, adapt to be installed on TS-35/7.5 or TS-35/15 mounting rails. The body is designed 85.5mm in width, which allows space saving inside the cabinets. The entire series adopts the full range AC input from 90VAC to 264VAC and conforms to EN61000-3-2, the norm the European Union regulates for harmonic current.

NDR-480 is designed with metal housing that enhances the unit's power dissipation. With working efficiency up to 92.5%, the entire series can operate at the ambient temperature between -20°C and 70°C under air convection. It is equipped with constant current mode for over-load protection, fitting various inductive or capacitive applications. The complete protection functions and relevant certificates for industrial control apparatus (UL508, TUV EN60950-1, and etc.) make NDR-480 a very competitive power supply solution for industrial applications.

■ Model Encoding

NDR - 480 - 24

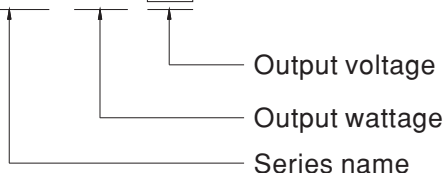



SPECIFICATION

MODEL		NDR-480-24	NDR-480-48
OUTPUT	DC VOLTAGE	24V	48V
	RATED CURRENT	20A	10A
	CURRENT RANGE	0 ~ 20A	0 ~ 10A
	RATED POWER	480W	480W
	RIPPLE & NOISE (max.) Note.2	150mVp-p	150mVp-p
	VOLTAGE ADJ. RANGE	24 ~ 28V	48 ~ 55V
	VOLTAGE TOLERANCE Note.3	± 1.0%	± 1.0%
	LINE REGULATION	± 0.5%	± 0.5%
	LOAD REGULATION	± 1.0%	± 1.0%
	SETUP, RISE TIME	1500ms, 100ms/230VAC 3000ms, 100ms/115VAC at full load	
HOLD UP TIME (Typ.)	16ms/230VAC 16ms/115VAC at full load		
INPUT	VOLTAGE RANGE Note.4	90 ~ 264VAC 127 ~ 370VDC	
	FREQUENCY RANGE	47 ~ 63Hz	
	POWER FACTOR (Typ.)	PF>0.98/115VAC, PF>0.94/230VAC at full load	
	EFFICIENCY (Typ.)	92.5%	92.5%
	AC CURRENT (Typ.)	4.8A/115VAC 2.4A/230VAC	
	INRUSH CURRENT (Typ.)	20A/115VAC 35A/230VAC	
	LEAKAGE CURRENT	<2mA / 240VAC	
PROTECTION	OVERLOAD	105 ~ 130% rated output power Protection type : Constant current limiting, unit will shut down after 3 sec., re-power on to recover	
	OVER VOLTAGE	29 ~ 33V	56 ~ 65V
	OVER TEMPERATURE	Shut down o/p voltage, recovers automatically after temperature goes down	
ENVIRONMENT	WORKING TEMP.	-20 ~ +70°C (Refer to "Derating Curve")	
	WORKING HUMIDITY	20 ~ 95% RH non-condensing	
	STORAGE TEMP., HUMIDITY	-40 ~ +85°C, 10 ~ 95% RH	
	TEMP. COEFFICIENT	± 0.03%/°C (0 ~ 50°C)	
	VIBRATION	Component:10 ~ 500Hz, 2G 10min./1cycle, 60min. each along X, Y, Z axes; Mounting: Compliance to IEC60068-2-6	
SAFETY & EMC (Note 4)	SAFETY STANDARDS	UI508, TUV EN60950-1 approved;(meet EN60204-1)	
	WITHSTAND VOLTAGE	I/P-O/P:3KVAC I/P-FG:2KVAC O/P-FG:0.5KVAC	
	ISOLATION RESISTANCE	I/P-O/P, I/P-FG, O/P-FG:>100M Ohms / 500VDC / 25°C / 70% RH	
	EMC EMISSION	Compliance to EN55022 (CISPR22), EN61204-3 Class B, EN61000-3-2,-3	
	EMC IMMUNITY	Compliance to EN61000-4-2,3,4,5,6,8,11, EN55024, EN61000-6-2 (EN50082-2), EN61204-3, heavy industry level, criteria A	
OTHERS	MTBF	146.8K hrs min. MIL-HDBK-217F (25°C)	
	DIMENSION	85.5*125.2*128.5mm (W*H*D)	
	PACKING	1.5Kg; 8pcs/13Kg/0.9CUFT	
NOTE	<p>1. All parameters NOT specially mentioned are measured at 230VAC input, rated load and 25°C of ambient temperature.</p> <p>2. Ripple & noise are measured at 20MHz of bandwidth by using a 12" twisted pair-wire terminated with a 0.1uf & 47uf parallel capacitor.</p> <p>3. Tolerance : includes set up tolerance, line regulation and load regulation.</p> <p>4. Installation clearances : 40mm on top, 20mm on the bottom, 5mm on the left and right side are recommended when loaded permanently with full power. In case the adjacent device is a heat source, 15mm clearance is recommended.</p> <p>5. Derating may be needed under low input voltage. Please check the derating curve for more details.</p> <p>6. The power supply is considered as an independent unit, but the final equipment still need to re-confirm that the whole system complies with the EMC directives. For guidance on how to perform these EMC tests, please refer to "EMI testing of component power supplies." (as available on http://www.meanwell.com)</p>		

Block Diagram

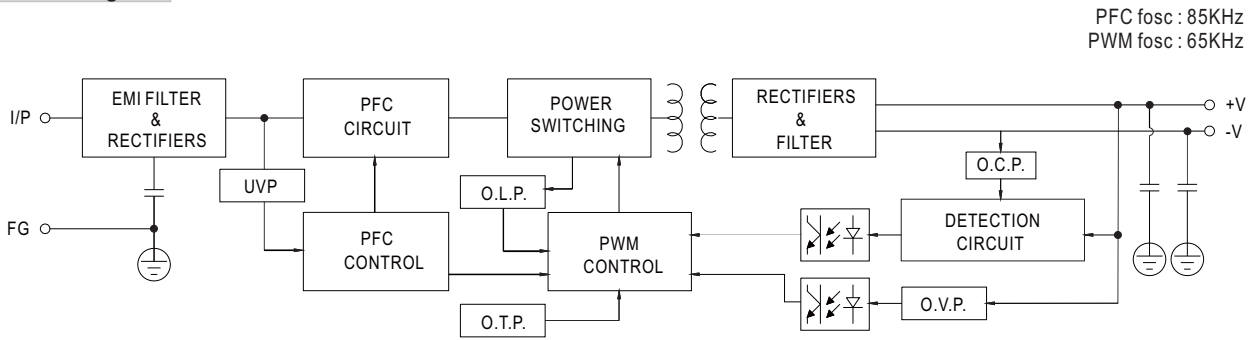

Derating Curve

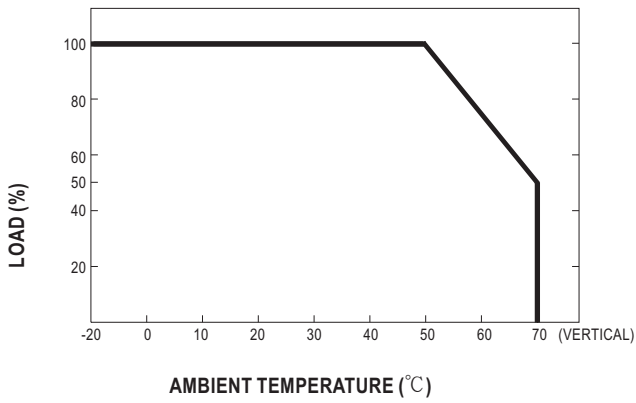

Output derating VS input voltage

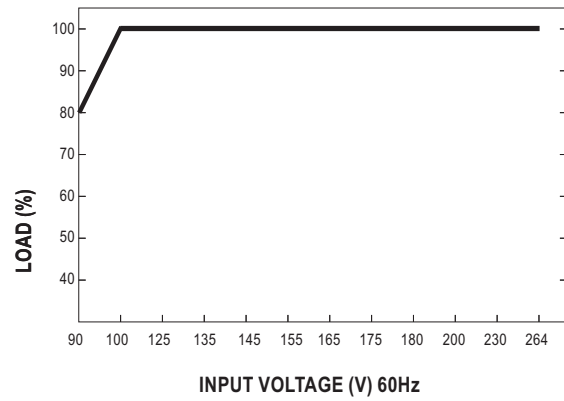

Mechanical Specification

Case No.984D Unit:mm

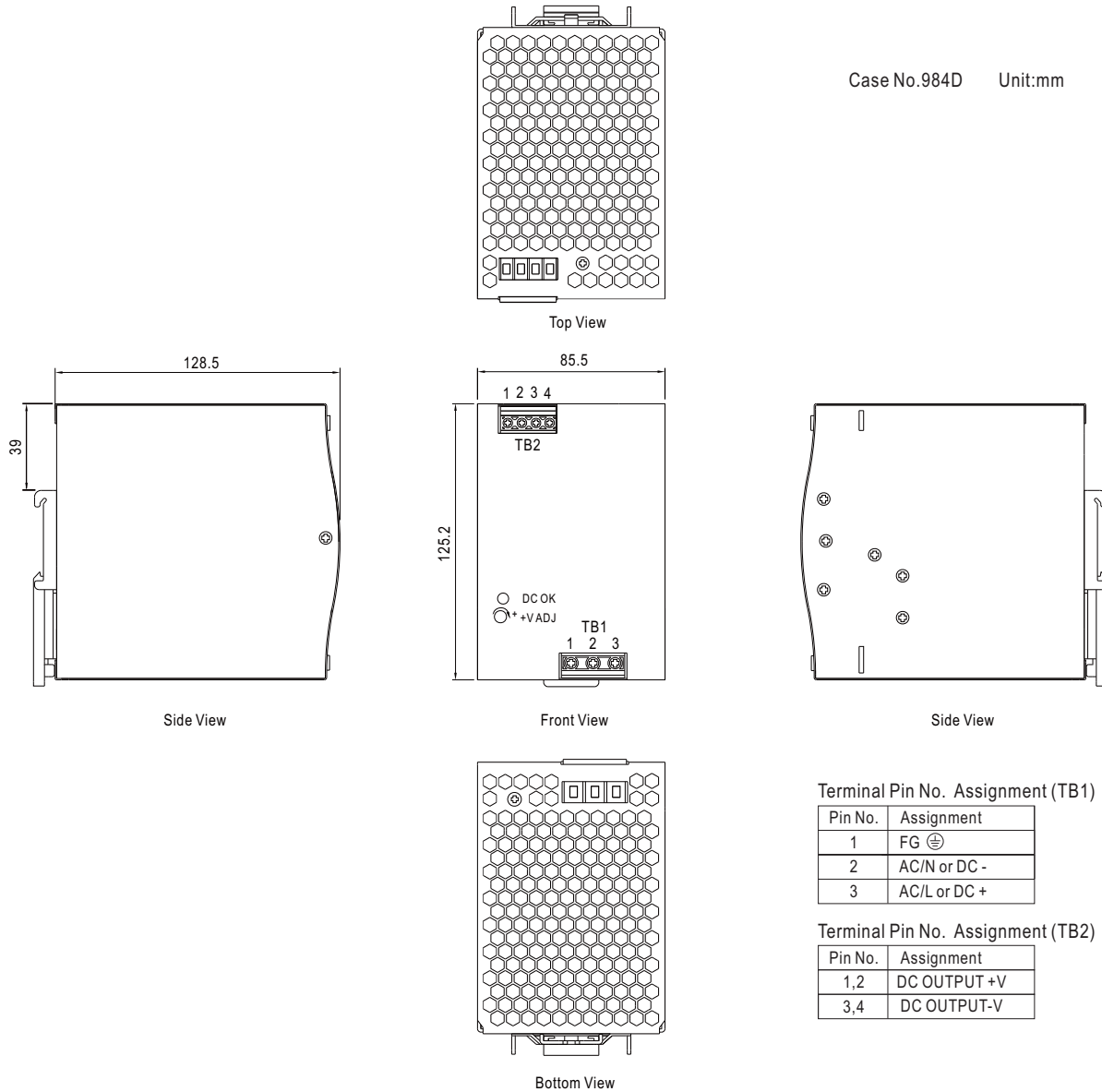

Installation Instruction

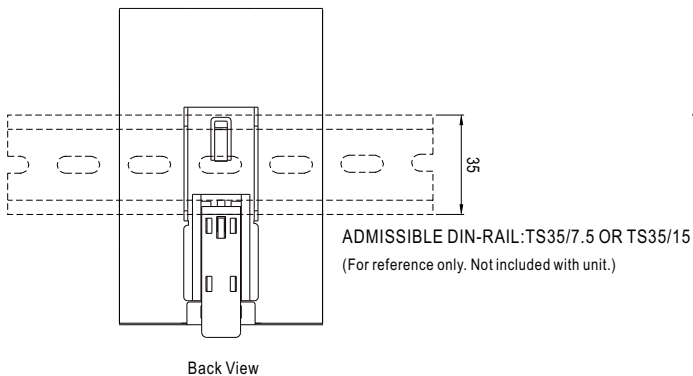

This series fits DIN rail TS35/7.5 or TS35/15.
For installation details, please refer to the Instruction manual.

Installation Manual

Please refer to : <http://www.meanwell.com/manual.html>